



















'H' Series 3 and 5 Valve Differential Pressure Manifolds

Catalog 4190-FM
June 2002



'H' series 3 and 5 valve manifolds

Contents

Page 3	Introduction		
Page 4/5	Bonnet assembly details and options		
Page 6/7	Manifold key features		
Page 8	3 Valve direct mount manifold Pipe to flange style		
Page 9	3 Valve direct mount manifold Base entry and flange style		
Page 10	3 Valve direct mount manifold Extruded body flange style		
Page 11	3 Valve direct mount manifold Compact cast body style		
Page 12	3 Valve remote manifold High pressure style		
Page 13	3 Valve manifold 3051 and Miniature style		
Page 14	5 Valve direct mount manifold Pipe to flange style		
Page 15	5 Valve direct mount manifold Custody transfer and oval flange style		
Page 16	5 Valve direct mount manifold 3051 and base entry style		
Page 17	5 Valve direct mount manifold Compact cast body style		
Page 18	5 Valve direct mount manifold Extruded body flange style		
Page 19	5 Valve remote manifold High pressure style		
Page 20/21	Manifold bracket mounting		
Page 22	PTFree connect		
Page 23	Material matrix		
Page 24-27	Manifold options		

'H' series 3 and 5 valve manifolds

Introduction

With years of manifold design and development experience Parker Hannifin are able to offer the most comprehensive range of differential pressure transmitter manifolds available to users for a wide variety of applications and industries. Now consolidated into one catalogue Parker is able to offer a simplified system of selection and choice for all Instrument applications and installations.

In addition to producing manifolds Parker also makes twin and single ferrule compression fittings A-LOK® and CPI™ which are used extensively in the oil, gas, petro-chem, power, processing and many other industries. Combining these as an integral part of manifold and valve bodies users can eliminate pipe threaded connections reducing leak paths and avoiding the use of thread sealant, a frequent menace to instrument and system performance.

All the valves offered in this catalogue are available with PTFree connections improving system performance, safety factors and simplifying installation and ultimately reducing customer costs.

Continuous product development may from time to time necessitate changes in the details contained in this catalogue. Parker Hannifin reserve the right to make such changes at their discretion and without prior notification.



All dimensions shown in this catalogue are approximate and subject to change.

! WARNING

FAILURE, IMPROPER SELECTION OR IMPROPER USE OF THE PRODUCTS AND/OR SYSTEMS DESCRIBED HEREIN OR RELATED ITEMS CAN CAUSE DEATH, PERSONAL INJURY AND PROPERTY DAMAGE.

This document and other information from Parker Hannifin Corporation, its subsidiaries and authorized distributors provide product and/or system options for further investigation by users having technical expertise. It is important that you analyze all aspects of your application and review the information concerning the product or system in the current product catalog. Due to the variety of operating conditions and applications for these products or systems, the user, through its own analysis and testing, is solely responsible for making the final selection of the products and systems and assuring that all performance, safety and warning requirements of the application are met.

The products described herein, including without limitation, product features, specifications, designs, availability and pricing, are subject to change by Parker Hannifin Corporation and its subsidiaries at any time without notice.

Offer of Sale

The items described in this document are hereby offered for sale by Parker Hannifin Corporation, its subsidiaries or its authorized distributors. This offer and its acceptance are governed by the provisions stated in the "Offer of Sale" located in catalog 4110-U Needle Valves (U Series).

'H' series 3 and 5 valve manifolds

Standard manifold globe style bonnet design

1. Positive handle retention design featuring broached square engagement positioned by thread locked grub screw.

2. "T" bar
Ergonomically designed for ease of operation. Anti-tamper and lockable devices can be supplied for on site retro-fit.

4. Gland packing adjuster
For maximum packing stability and performance, simple and easily adjustable for gland wear compensation.

6. Valve Bonnet
Standard construction for maximum pressure rating with replaceable bonnet sealing washer arrangement.

8. Thrust Bush
Anti rotational adjustor bush ensures uniform packing compression, maximising pressure tight sealing and limiting cold flow passages.

10. Bonnet/body washer
Annealed sealing washer to ensure complete atmospheric leakage and allowing on site retro-fit of bonnets with 100% re-sealing assurance

For safe reliable and repeatable performance

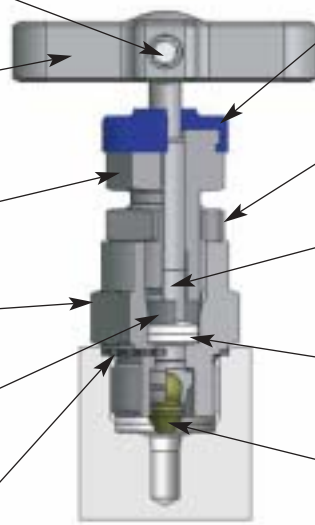

3. Dust Cap

This has a dual purpose, preventing air born debris from contaminating the operating spindle thread and providing colour coded functional identification. Isolate (BLUE) Bleed/test (RED).

5. Gland adjuster lock nut

A secure anti vibration locking mechanism to prevent inadvertent gland adjuster loosening.

7. Anti blowout spindle

Designed for low torque operation with high quality micro mirror stem finish for positive gland sealing.

9. Gland packing (adjustable)

Chevron style dual piece gland packing to provide maximum sealing area contact with minimum gland adjustment.

11. Spindle tip

Self centering, non-rotational tip gives successive positive bubble tight shut off assuring the user of leakage free performance and downstream functional safety.

All metallic standard parts are produced in stainless steel, for alternative materials please refer to page 23. Manifolds produced in other specified materials will be provided with non-wetted parts as standard in stainless steel, this applies to items 1, 2, 4, 5 & 8.

Specification

- Height closed (standard and HP) = 47mm (1.85")
Height open (standard and HP) = 50.3mm (2.00")
- Number of turns open/close - 3.5.
- Stainless steel construction.
- Maximum standard pressure up to 6,000 psig (414 barg).
- Maximum optional pressure (limited to HP suffix see page 12 & 19) up to 10,000 psig (689 barg).
- Temperature rating -54C to +538C (-65F to +1000F).
- PTFE standard gland packing (Graphoil optional).
- Maximum temperature PTFE 260C (500F).
- Maximum temperature Graphoil 538C (1000F).

Features

- Standard unit throughout manifold range.
- Operating threads outside washout area.
- Externally adjustable gland.
- Low operating torque.
- Alternative 10,000 psig (689 barg) range available.
- Retro-fit kit for:-
Anti-tamper spindle.
Panel mounting.
Lockable T bar.
Handwheel with lockable option.
- Bonnet locking pin to prevent accidental removal fitted as standard.
- Alternative graphite packing for high temperature performance available.
- Alternative self centering tip materials available for gaseous and aggressive fluids.
- Safety back seated spindle prevents stem blowout and provides secondary back up stem seal.
- Packing below threads to prevent lubricant washout.
- All valves 100% factory tested.
- NACE certified wetted parts available.
- Optional cleaned and lubricated suitable for Oxygen service.
- Heat code traceable body and bonnet.

Pressure vs temperature

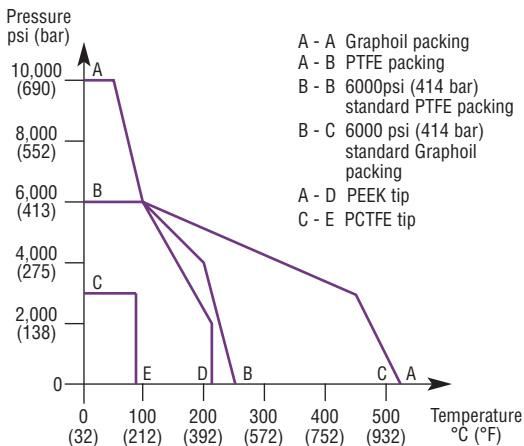

'H' series 3 and 5 valve manifolds

Optional manifold globe style bonnet design

For on-site assembly

The design options below can be simply retrofit to any "H" series standard manifold. Retrofit kit part numbers are listed next to the illustrated option and all parts will be supplied in stainless steel regardless of the parent body material.

For factory fitted assembly







To obtain factory assembled options the manifold part number must be suffixed with the option and function designator. This allows you to select one or both of the bonnets to be fitted with the selected option or, different options to be fitted to either of the bonnets.

Function designator IS – isolate, DR – drain/test, EQ – equalize.

Example HD*5MATDR – manifold with drain/bleed valves (DR) fitted with anti-tamper (AT). Isolate valves will be standard bonnet design.

Example HL*5MHWISTHLDR – manifold with isolate valves fitted with hand-wheel and drain/bleed valves fitted with "T" bar locking mechanism.

Note: Padlocks for lockable handwheels and "T" bars are not supplied (hole size 6mm/0.24").

Standard bonnet	T bar handle locking	Anti tamper spindle
	 Retro-fit kit part number KITTHL Factory assembled suffix THL	 For key only - part no. ATHKEY/1 Retro-fit kit part number KITAT without key KITATK with key Factory assembled suffix AT without key ATK with key
Handwheel	Lockable handwheel	*Panel mounting
 Retro-fit kit part number KITHW Factory assembled suffix HW	 Retro-fit kit part number KITLHW Factory assembled suffix LHW	 Retro-fit kit part number KITPM Factory assembled suffix PM

*Panel mounting hole diameter = 26mm (1.02").
 Panel thickness = Max 5mm (0.20") Min 2.3mm (0.09").

'H' series 3 and 5 valve manifolds

Three and five valve manifolds for direct or remote mounting

Purpose

Instrument manifolds are a consolidation of single valves into a unitised block and allow engineers the flexibility to perform various tasks and functions without removing the transmitter from its installed position.

Manifold key features (example)

Bonnet assemblies: are all functionally colour coded, 3 valve manifolds are provided with **2 IS** and **1 EQ**. 5 valve manifolds are provided with **2 IS**, **2 DR** and **1 EQ** (as illustrated here). Alternatively 5 valve manifolds for custody transfer/fiscal metering are fitted with **2 IS**, **1DR** and **2 EQ**. For extruded style manifold blocks straight through flow rising plug style valves can be fitted.

Functional colour coding:
RED =
Drain/vent/test
BLUE =
Isolate/block
GREEN =
Equalize

Manifold body: this is standard compact bar stock style suitable for enclosure installation. Extruded forms are also available as standard.

Process inlet connections positioned on front face 1/2" NPT female threads or kidney flange/oval/futbol are standard. Alternative thread forms, socket or butt weld and PTFree connections are available. Standard connections are on 2.125"/54mm.

Drain/bleed connections the position depends upon manifold design but are generally on the bottom face of the manifold. Other optional positions are available. On 3 valve manifold systems test and purge ports are optional choices.

Manifold marking: all manifolds are permanently marked with line diagram showing manifold capability.

Example:

316SS
 Part No: HDS5M
 PTFE: 260 Deg C (500 F) max.
 Model: A1.....1/2NPT/1/4NPT

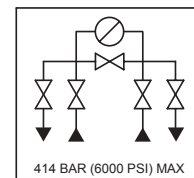

All Parker direct mount manifolds are rated up to 6000psig (414 barg). Remote mount 10,000psig (689 barg) are available

'H' series 3 and 5 valve manifolds

Three and five valve manifolds for direct or remote mounting

Instrument side, outlet, flange connections: are standard for direct mount manifolds with machined grooves for PTFE seal rings. Optional DIN sealing groove arrangement is also available. Remote style manifolds are provided as standard with 1/2" NPT female outlet connections (alternative thread forms etc. are available). Flanged outlets are positioned on 54mm/2.125" centres. (56/57mm options are available). Manifolds for 3051 style transmitters are available as standard

Pressure rating:
 maximum standard rating
 6000psig (414 barg).
 Remote mount
 10,000psig (689 barg) are available

Seal rings:

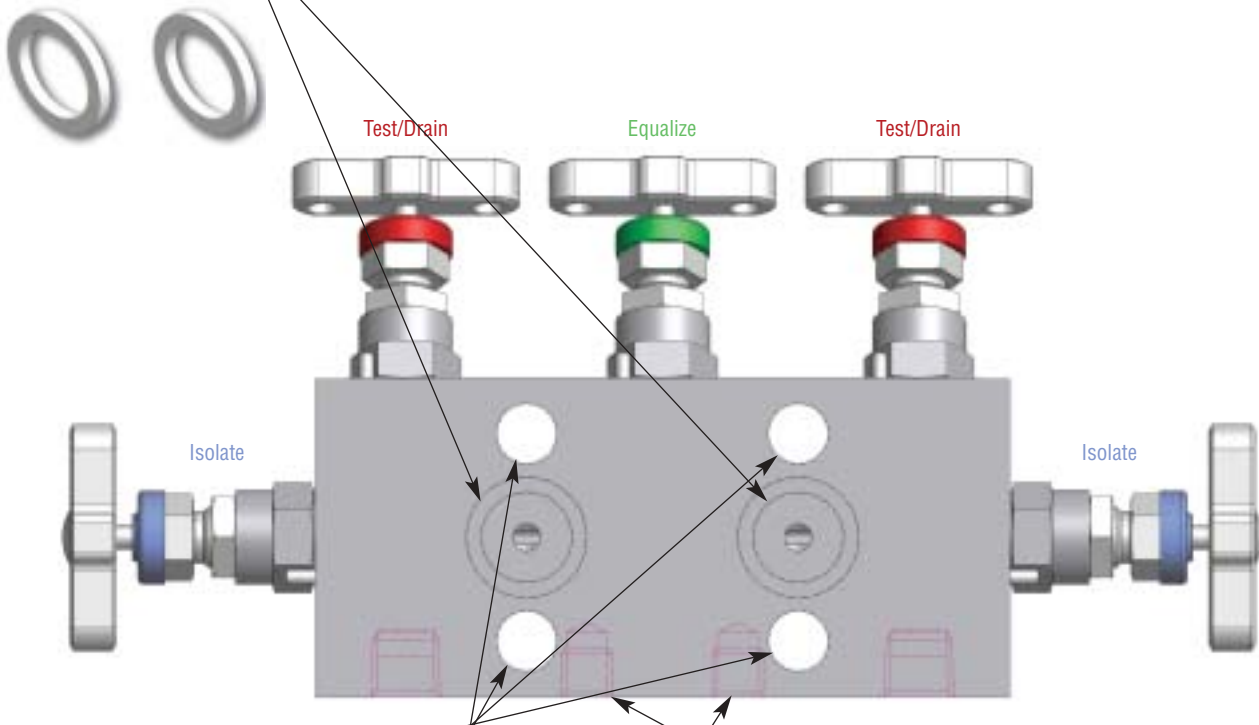

Manifold to transmitter mounting: all direct mount manifolds are provided with 4 off 7/16 UNF x 1.625" high tensile zinc plated carbon steel bolts. Bolt holes are standard on 54mm/2.125" centres. Optional St. St. bolts are available.

Manifold base/bracket mounting: all manifolds are provided with bracket mounting holes. This provides the user with the opportunity to bracket mount the instrument allowing installation to take place without the instrument and to give full mounting support in the event of Instrument removal.

Bolts:



Material: Products in this catalog are standard in stainless steel and can also be produced in many other materials as shown on page 23. For full material specifications please refer to the technical section.

Pressure vs temperature

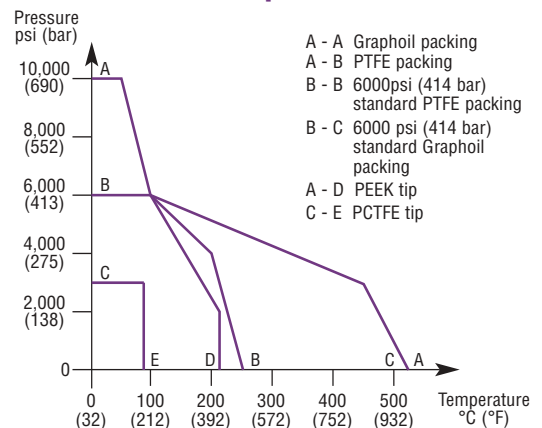

'H' series 3 and 5 valve manifolds

Three valve manifold

Compact design for direct mounting to differential pressure transmitters with 54mm/2.125" mounting centres, supplied with instrument mounting bolts and PTFE seals. Test ports available as standard on top face (plugs to be ordered separately - not fitted). Purge port options available.

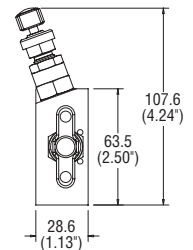
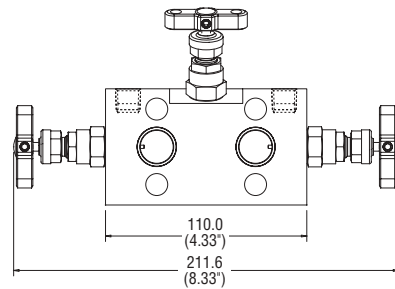

HD*3MDTP

Part No.	Inlet/process	Outlet/inst.	Drain/bleed/test
HD*3M	1/2" NPT	Flanged	-
HD*3MDTP	1/2" NPT	Flanged	1/4" NPT

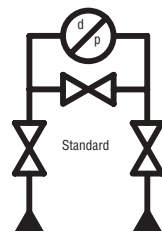

HD*3M

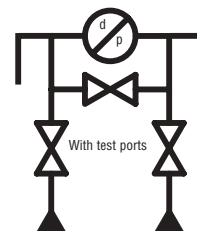

HD*3MDTP

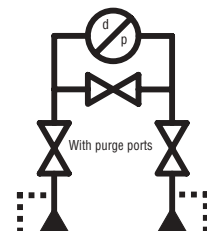

Three valve manifold

Compact design particularly suited for enclosure installation and for direct mounting to differential pressure transmitters with 54mm/2.125" mounting centres, supplied with instrument mounting bolts and PTFE seals. Additional test or purge port options are available.

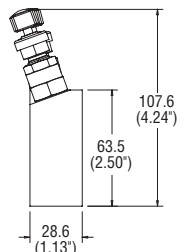
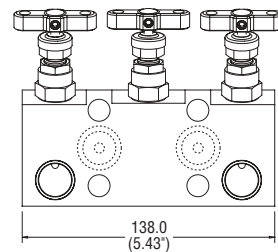

HD*3

Part No.	Inlet/process	Outlet/inst.	Drain/bleed/test
HD*3	1/2" NPT	Flanged	Optional

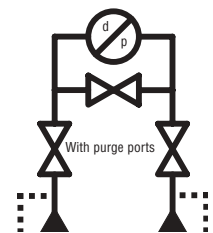
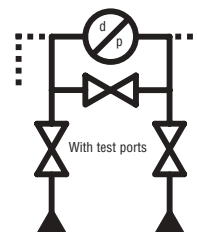
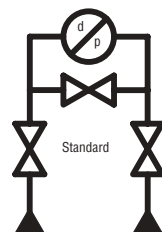

* Insert material designator see page 23

For full list of options see page 24 - 27

'H' series 3 and 5 valve manifolds

Three valve manifold

Specifically designed for installation inside enclosures enabling bottom entry connections to be completed outside of the enclosure. Suitable for direct mounting to differential pressure transmitters with 54mm/2.125" mounting centres, supplied with instrument mounting bolts and PTFE seals. Additional test or purge port options are available.

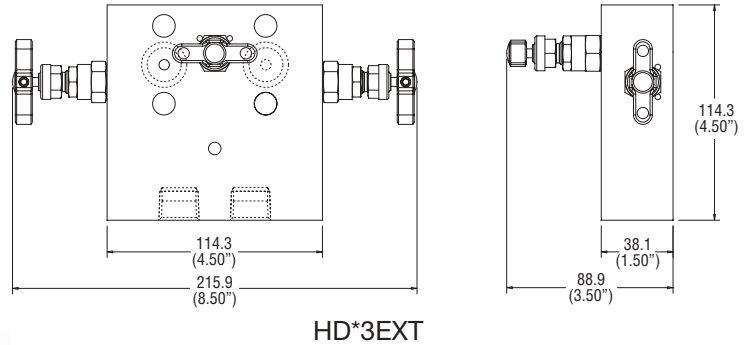

Part No.	Inlet/process	Outlet/inst.	Drain/bleed/test
HD*3EXT	1/2" NPT	Flanged	Optional

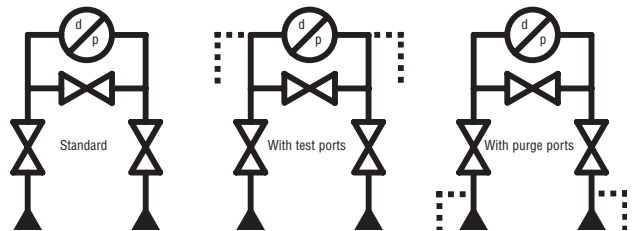

Three valve manifold

Compact design suitable for direct mounting to differential pressure transmitters with 54mm/2.125" mounting centres. Process/inlet connections are via standard kidney flange ovals/futbols. Manifold supplied with instrument mounting bolts and PTFE seals. Additional test or purge port options are available.

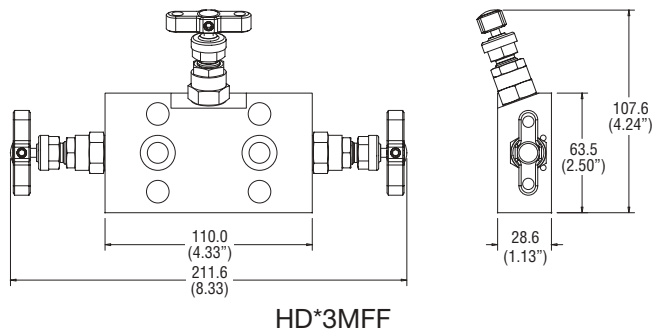

Part No.	Inlet/process	Outlet/inst.	Drain/bleed/test
HD*3MFF	Flanged	Flanged	Optional

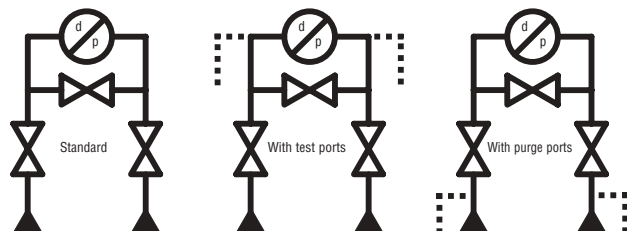

* Insert material designator see page 23

For full list of options see page 24 - 27

'H' series 3 and 5 valve manifolds

Three valve manifold

Extruded body design for direct mounting to differential pressure transmitters with 54mm/2.125" mounting centres, supplied with instrument mounting bolts and PTFE seals. Additional test or purge port options are available.

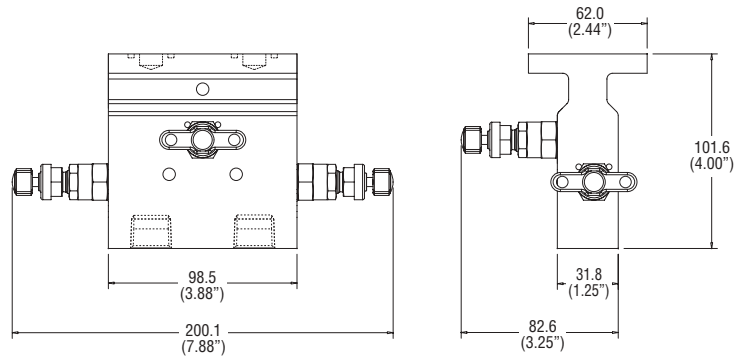

HEF*38N

Part No.	Inlet/process	Outlet/inst.	Drain/bleed/test
HEF*38N	1/2" NPT	Flanged	Optional

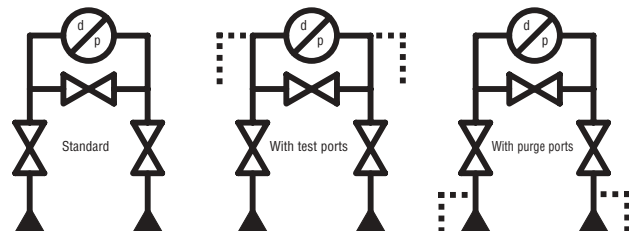

Three valve manifold

Compact design suitable for direct mounting to differential pressure transmitters with 54mm/2.125" mounting centres. Process/inlet connections are via standard kidney flange ovals/futbols. Manifold supplied with instrument mounting bolts and PTFE seals. Additional test or purge port options are available. Roddable option available (see CAT4190HV page 6 & 7 for rising plug valve details).

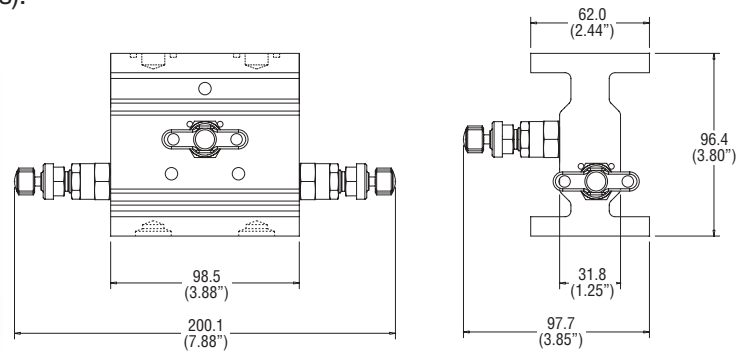

HEF*3

Part No.	Inlet/process	Outlet/inst.	Drain/bleed/test
HEF*3	Flanged	Flanged	Optional

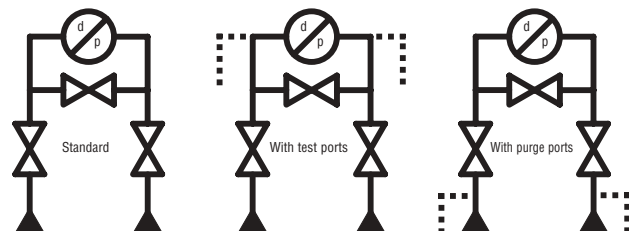

* Insert material designator see page 23

For full list of options see page 24 - 27

'H' series 3 and 5 valve manifolds

Three valve manifold

Compact cast body design with optimum positioning of equalize valve for easy access and operation. Manifold suitable for direct mounting to differential pressure transmitters with 54mm/2.125" mounting centres, supplied with instrument mounting bolts and PTFE seals. Additional test or purge port options are available.

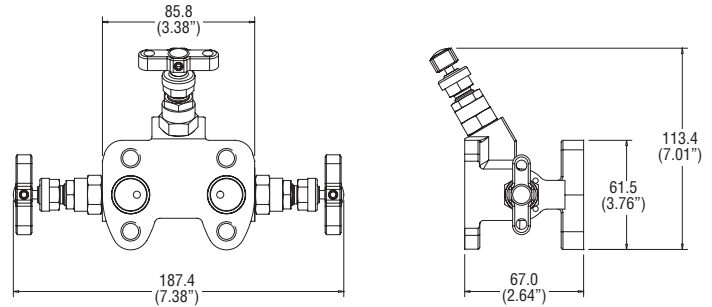

HFS38N

Part No.	Inlet/process	Outlet/inst.	Drain/bleed/test
HF*38N	1/2" NPT	Flanged	Optional

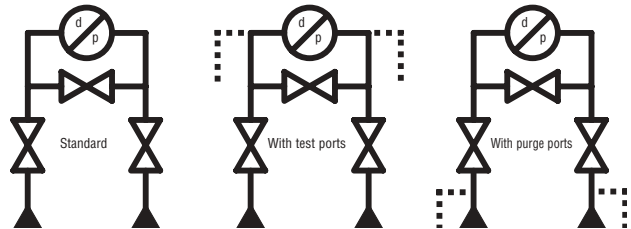

Three valve manifold

Compact cast body design with optimum positioning of equalize valve for easy access and operation. Manifold suitable for direct mounting to differential pressure transmitters with 54mm/2.125" mounting centres. Process/inlet connections are via standard kidney flange ovals/futbols. Manifold supplied with instrument mounting bolts and PTFE seals. Additional test or purge port options are available.

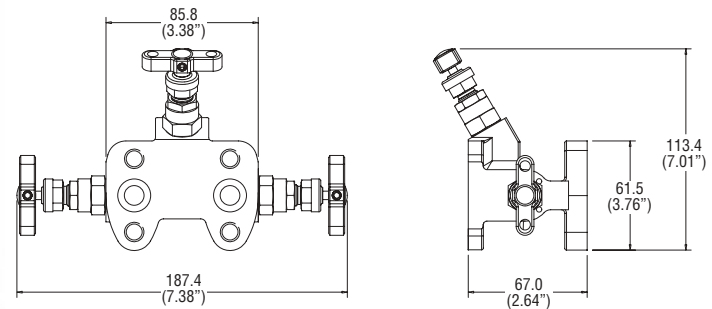

HFS3

Part No.	Inlet/process	Outlet/inst.	Drain/bleed/test
HF*3	Flanged	Flanged	Optional

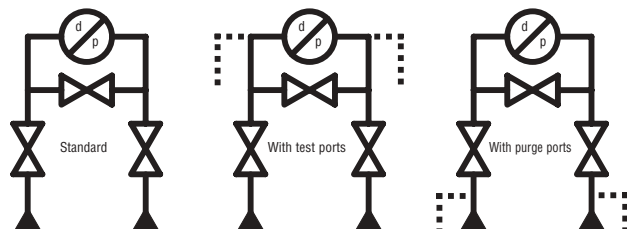

* Insert material designator see page 23

For full list of options see page 24 - 27

'H' series 3 and 5 valve manifolds

Three valve manifold

Compact design for remote installation from differential pressure transmitters. Test ports available as standard on top face (plugs to be ordered separately - not fitted). Purge port options available.

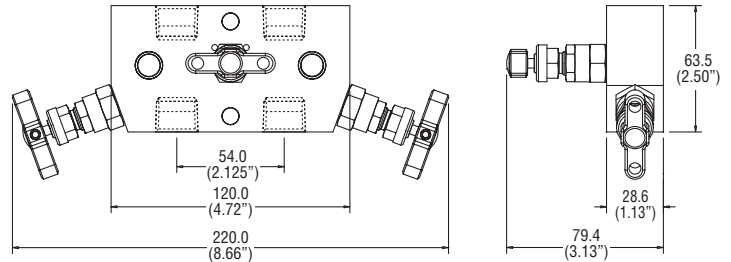

HL*3MDTP

Part No.	Inlet/process	Outlet/inst.	Drain/bleed/test
HL*3M	1/2" NPT	1/2" NPT	Optional
HL*3MDTP	1/2" NPT	1/2" NPT	1/4" NPT

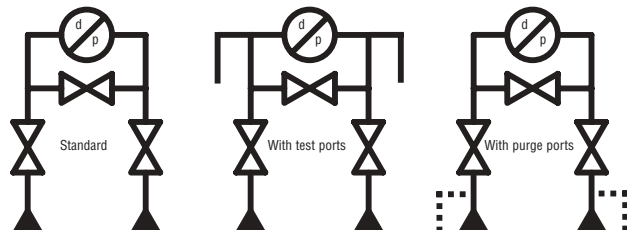

HL*3M

HL*3MDTP

Three valve manifold for 10,000 psig (689 bar)

Compact design for remote installation from differential pressure transmitter. Additional test or purge port options are available.

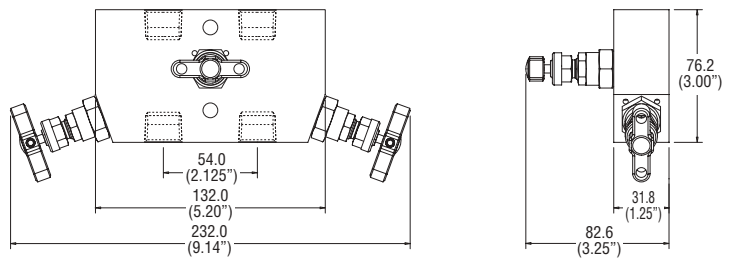

HL*3MHP

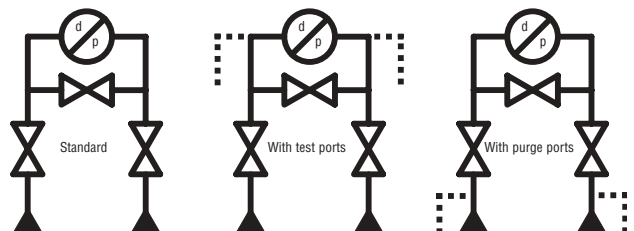

Part No.	Inlet/process	Outlet/inst.	Drain/bleed/test
HL*3MHP	1/2" NPT	1/2" NPT	Optional

* Insert material designator see page 23

For full list of options see page 24 - 27

'H' series 3 and 5 valve manifolds

Three valve manifold for model 3051 transmitter

Specifically designed for mounting to the 3051 series of differential pressure transmitters with outlets positioned to avoid the use of the adaptor/convertor flange. Inlet connections are on 54mm/2.125". These manifolds are not supplied with sealing rings, bolts are provided. Additional test or purge port options are available.

HD*3MCP

Part No.	Inlet/process	Outlet/inst.	Drain/bleed/test
HD*3MCP	1/2" NPT	For 3051	Optional

Miniature remote mount manifold

Parker's range of miniature valves and manifolds are ideal for installation inside control panels and other size limited installations where **space** and **weight** are primary considerations.

Technical specification, Pressure vs temperature

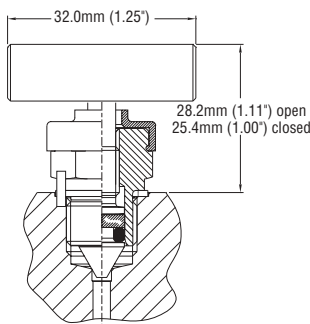
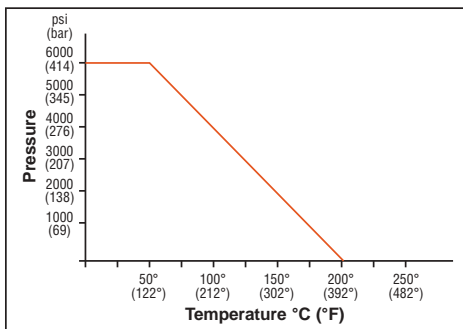

Specification

- Maximum pressure: 414 bar (6000 psi)
- Maximum temperature: 204° C (400° F)
- Packing seal ring: Fluorocarbon Rubber
- Back up ring: P.T.F.E.
- Material of construction: Stainless steel
- Seat construction: Metal/metal

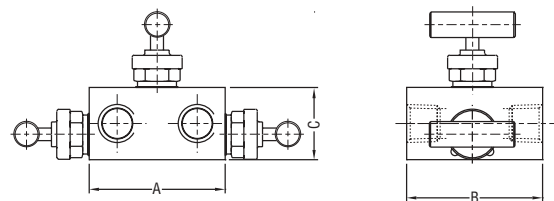

Part Number	Dimensions mm (inch)				
	Inlet	Outlet	A	B	C
MLS3V4N	2 - 1/4" NPT female	2 - 1/4" NPT female	50.8mm (2.0")	50.8mm (2.0")	27.0mm (1.08")

* Insert material designator see page 23

For full list of options see page 24 - 27

'H' series 3 and 5 valve manifolds

Five valve manifold

Compact design for direct mounting to differential pressure transmitters with 54mm/2.125" mounting centres, supplied with instrument mounting bolts and PTFE seals.

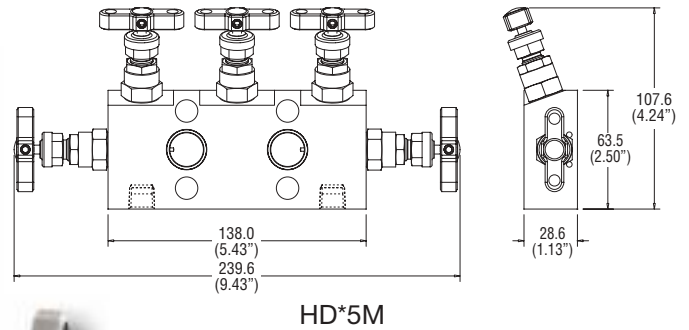

HD*5M

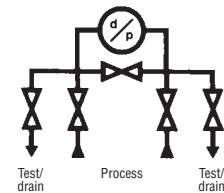

Part No.	Inlet/process	Outlet/inst.	Drain/bleed/test
HD*5M	1/2" NPT	Flanged	1/4" NPT

Five valve manifold

Compact design particularly suited for enclosure installation and for direct mounting to differential pressure transmitters with 54mm/2.125" mounting centres, supplied with instrument mounting bolts and PTFE seals.

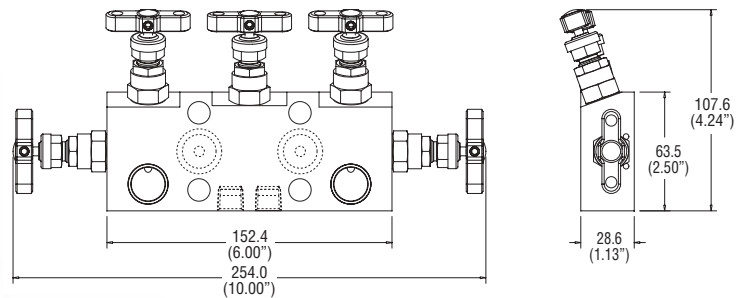

HD*5

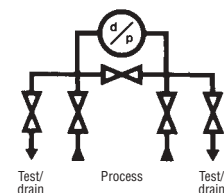

Part No.	Inlet/process	Outlet/inst.	Drain/bleed/test
HD*5	1/2" NPT	Flanged	1/4" NPT

* Insert material designator see page 23

For full list of options see page 24 - 27

'H' series 3 and 5 valve manifolds

Five valve manifold

Compact design suitable for direct mounting to differential pressure transmitters with 54mm/2.125" mounting centres. Process/inlet connections are via standard kidney flange ovals/futbol. Manifold supplied with instrument mounting bolts and PTFE seals.

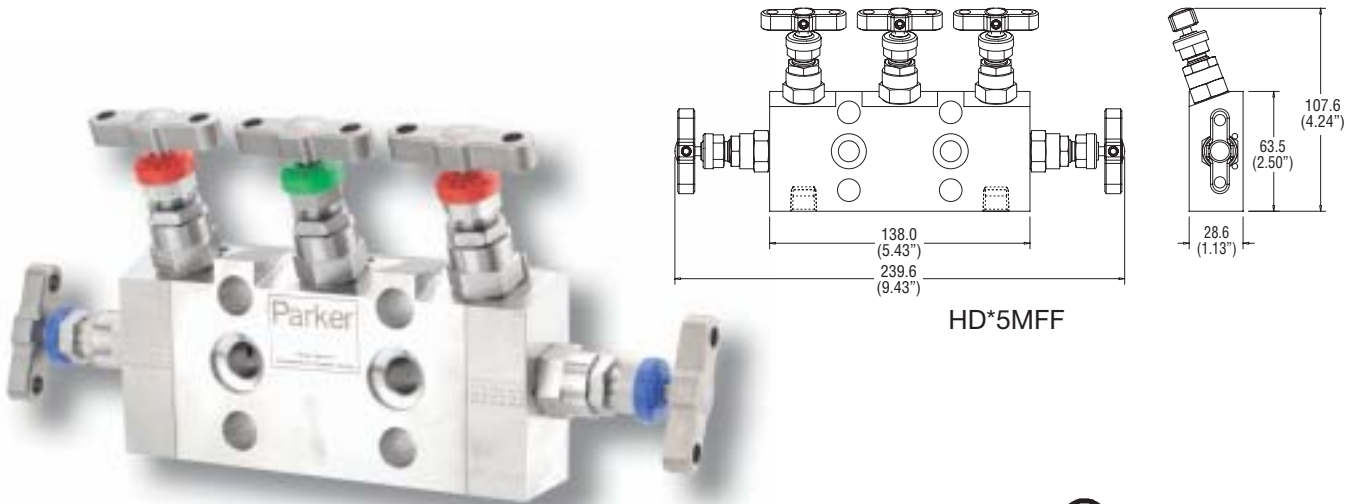

Part No.	Inlet/process	Outlet/inst.	Drain/bleed/test
HD*5MFF	Flanged	Flanged	1/4" NPT

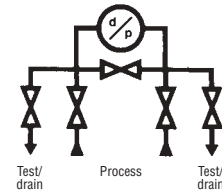

Five valve custody transfer/fiscal metering manifold

Compact design for direct mounting to differential pressure transmitters with 54mm/2.125" mounting centres, supplied with instrument mounting bolts and PTFE seals.

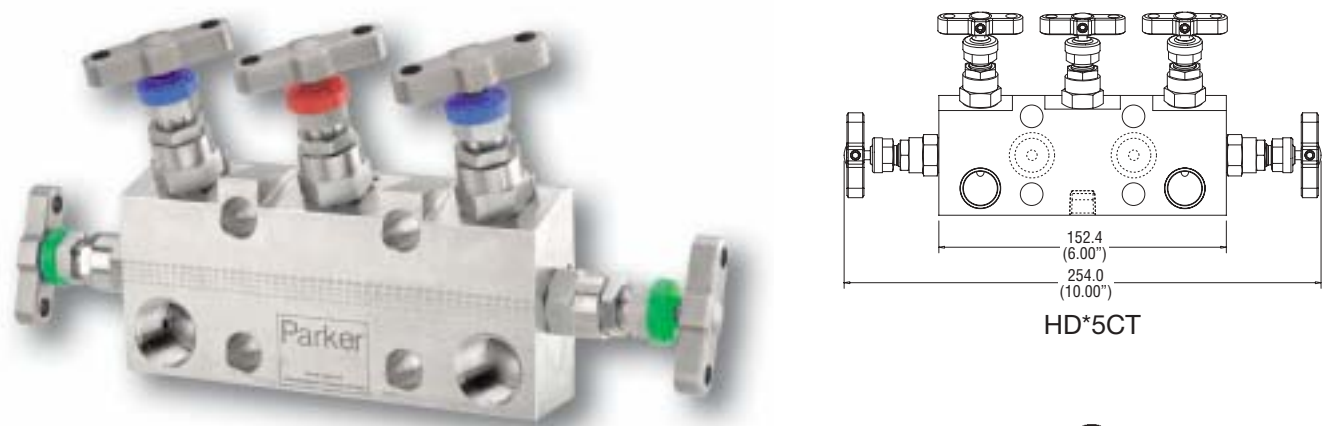

Part No.	Inlet/process	Outlet/inst.	Drain/bleed/test
HD*5CT	1/2" NPT	Flanged	1/4" NPT

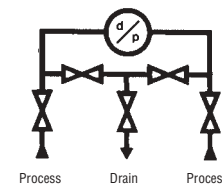

* Insert material designator see page 23

For full list of options see page 24 - 27

'H' series 3 and 5 valve manifolds

Five valve manifold

Specifically designed for installation inside enclosures enabling bottom entry connections to be completed outside of the enclosure. Suitable for direct mounting to differential pressure transmitters with 54mm/2.125" mounting centres, supplied with instrument mounting bolts and PTFE seals.

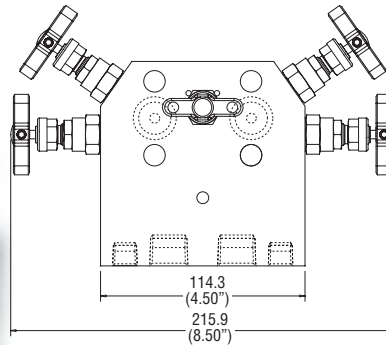

HD*5EXT

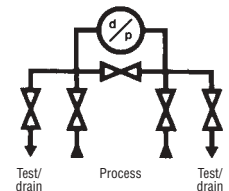
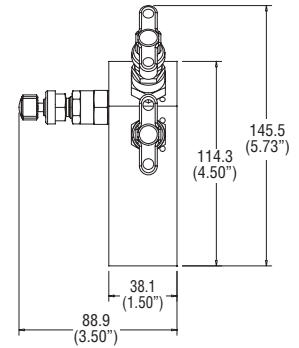

Standard

Part No.	Inlet/process	Outlet/inst.	Drain/bleed/test
HD*5EXT	1/2" NPT	Flanged	1/4" NPT

Five valve manifold for model 3051 transmitter

Specifically designed for mounting to the 3051 series of differential pressure transmitters with outlets positioned to avoid the use of the adaptor/convertor flange. Inlet connections are on 54mm/2.125". These manifolds are not supplied with sealing rings, bolts are provided.

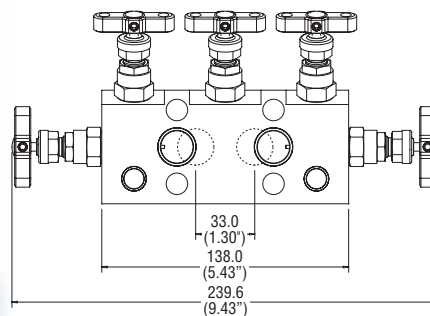

HD*5MCP

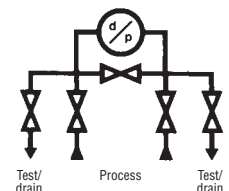
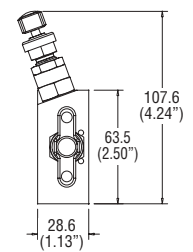

Standard

Part No.	Inlet/process	Outlet/inst.	Drain/bleed/test
HD*5MCP	1/2" NPT	Flanged	1/4" NPT

* Insert material designator see page 23

For full list of options see page 24 - 27

'H' series 3 and 5 valve manifolds

Five valve manifold

Compact cast body design with optimum positioning of equalize valve for easy access and operation. Manifold suitable for direct mounting to differential pressure transmitters with 54mm/2.125" mounting centres. Process/inlet connections are via standard kidney flange ovals/futbol. Manifold supplied with instrument mounting bolts and PTFE seals.

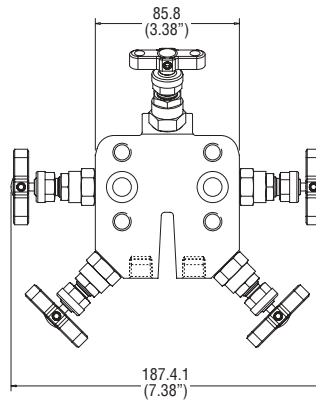

HFS5

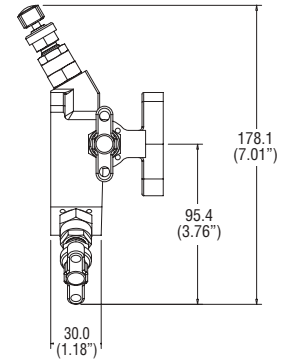

Part No.	Inlet/process	Outlet/inst.	Drain/bleed/test
HF*5	Flanged	Flanged	1/4" NPT

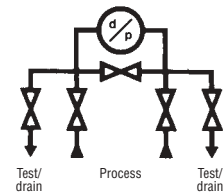

Five valve manifold

Compact cast body design suitable for direct mounting to differential pressure transmitters with 54mm/2.125" mounting centres. Manifold supplied with instrument mounting bolts and PTFE seals.

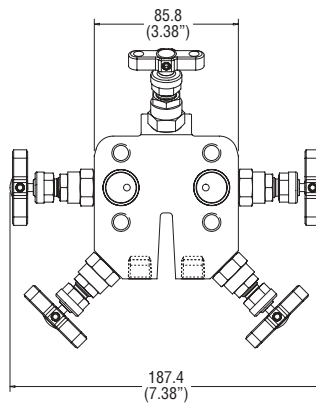

HFS58N

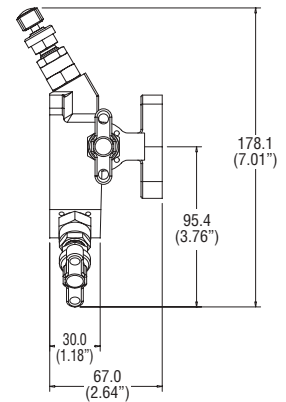

Part No.	Inlet/process	Outlet/inst.	Drain/bleed/test
HF*58N	1/2" NPT	Flanged	1/4" NPT

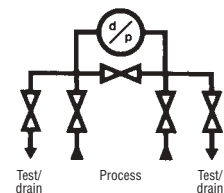

Standard

* Insert material designator see page 23

For full list of options see page 24 - 27

'H' series 3 and 5 valve manifolds

Five valve custody transfer/fiscal metering manifold

Compact design suitable for direct mounting to differential pressure transmitters with 54mm/2.125" mounting centres. Process/inlet connections are via standard kidney flange ovals/futbol. Manifold supplied with instrument mounting bolts and PTFE seals. Optional rising plug valve with 6.4mm (1/4") straight through flow pattern for isolating position available (see CAT 4190HV page 6 & 7 for full specification details).

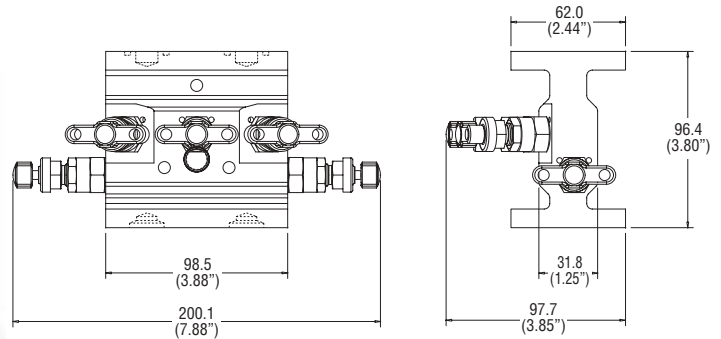

HEF*5CT

Part No.	Inlet/process	Outlet/inst.	Drain/bleed/test
HEF*5CT	Flanged	Flanged	1/4" NPT

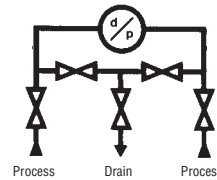

Standard

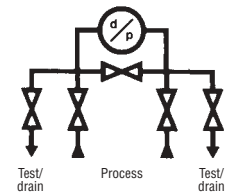

Option

Five valve custody transfer/fiscal metering manifold

Compact design for direct mounting to differential pressure transmitters with 54mm/2.125" centres, supplied with instrument mounting bolts and PTFE seals. Optional rising plug valve with 6.4mm (1/4") straight through flow pattern for isolating position available (see CAT 4190HV page 6 & 7 for full specification details).

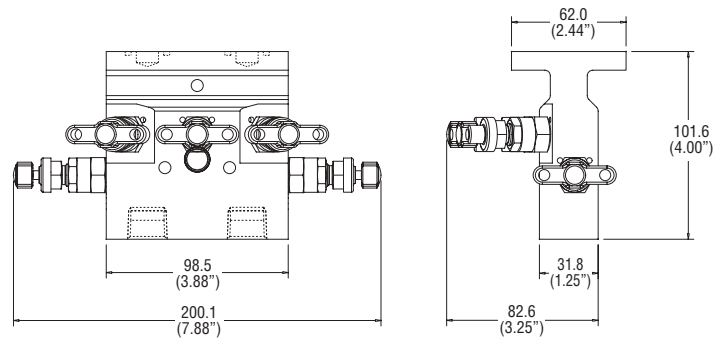

HEF*58NCT

Part No.	Inlet/process	Outlet/inst.	Drain/bleed/test
HEF*58NCT	1/2" NPT	1/2" NPT	1/4" NPT

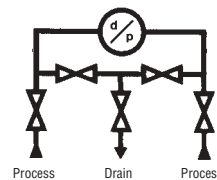

Standard

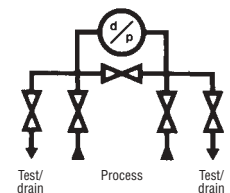

Option

* Insert material designator see page 23

For full list of options see page 24 - 27

'H' series 3 and 5 valve manifolds

Five valve manifold

Compact design manifold for remote installation from differential pressure transmitters. Optional custody transfer/fiscal metering available.

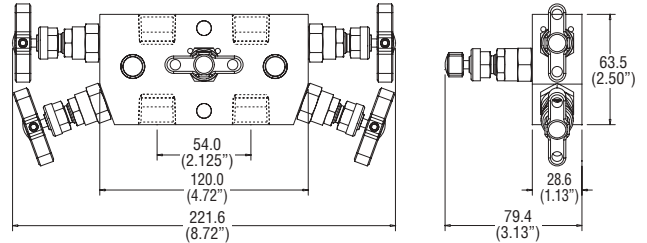

HL*5M

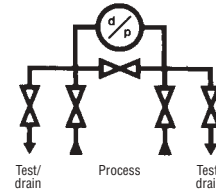

Standard

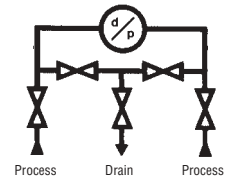

Option

Part No.	Inlet/process	Outlet/inst.	Drain/bleed/test
HL*5M	1/2" NPT	1/2" NPT	1/4" NPT

Five valve manifold for 10,000 psig (689 barg)

Compact design manifold for remote installation from differential pressure transmitters. Standard inlet, outlet and test/bleed connections in NPT.

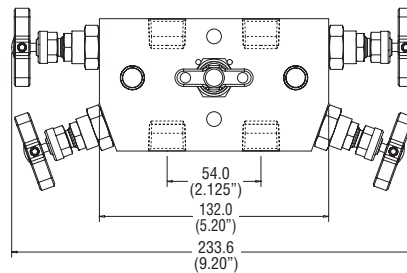

HL*5MHP

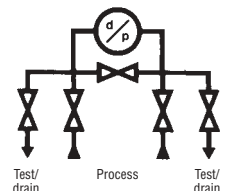
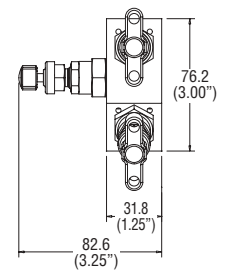

Part No.	Inlet/process	Outlet/inst.	Drain/bleed/test
HL*5MHP	1/2" NPT	1/2" NPT	1/4" NPT

* Insert material designator see page 23

For full list of options see page 24 - 27

'H' series 3 and 5 valve manifolds

Manifold bracket support

Purpose

It is essential to fully support impulse/pressure measurement tubing lines, manifolds and instruments. All Parker manifolds are designed to accommodate bracket mounting and support, a full range of brackets with additional U bolts are available.

Brackets are designed for panel and wall mounting and give full clearance for ease of handle operation. They are also suitable for vertical and horizontal positioning on 2" pipe-stand.

Standard brackets are produced from 4mm thick carbon steel plate to provide maximum rigidity and support. For full corrosion protection the brackets are shot blasted and zinc sprayed. Alternative bracket material is available upon request.

Part No. BKT5CS

Suitable for:-
HD*5
HD*5CT

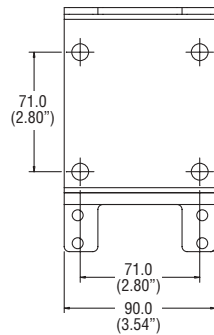
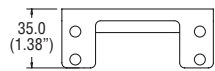

Simple to install bracket on horizontal or vertical 2" standpipe. Designed for horizontal or vertical mounting of manifold giving total installation flexibility.

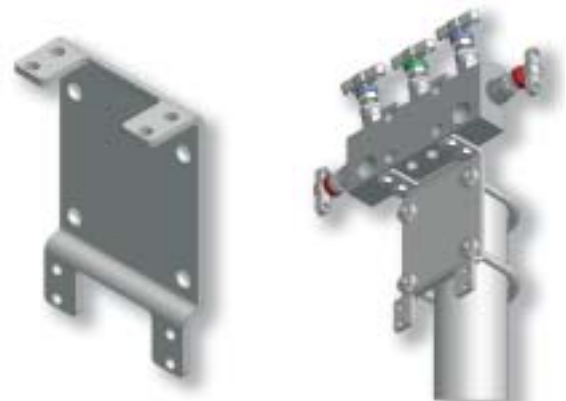
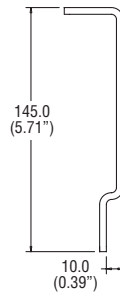

For 'U' bolts suffix part no. with B
Example BKT5CSB

BKT5CS

For manifold/bracket bolts add 'bolt set' suffix from matrix. Example: Bracket, 'U' bolts and manifold/bracket bolts BKT5CSB6 (suitable for HD*5).

Part No. BKT2CS

Suitable for the above and:-
HL*3M
HL*3MHP
HL*3MDTP
HL*5M
HL*5HP

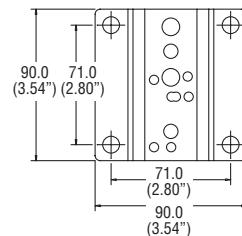

Universal manifold mounting bracket suitable for all remote mount manifolds. This bracket allows 90 degree positioning enabling total installation flexibility and prevents handle obstruction. Can be wall, standpipe or base mounted.

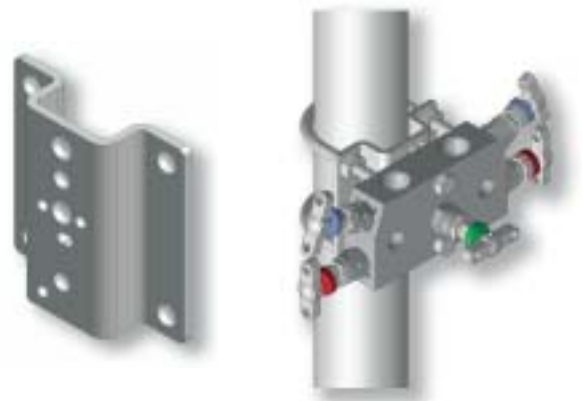

For 'U' bolts suffix part no. with A
Example BKT2CSA

BKT2CS

For manifold/bracket bolts add 'bolt set' suffix from matrix. Example: Bracket, 'U' bolts and manifold/bracket bolts BKT2CSA5 (suitable for HL*3M).

'H' series 3 and 5 valve manifolds

Manifold bracket support

Part No. BKT3CS

Suitable for:-
 HD*3M
 HD*3MDTP
 HD*3
 HD*3MFF
 HD*3MCP
 HD*5M
 HD*5
 HD*5MFF
 HD*5MCP

For 'U' bolts suffix
 part no. with B
 Example BKT3CSB

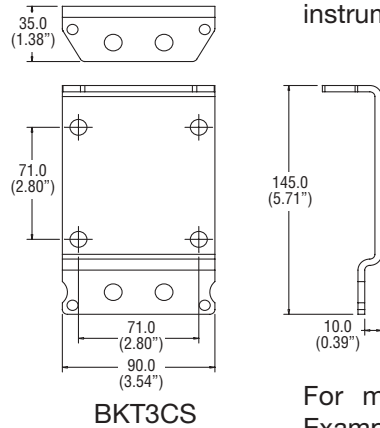

BKT3CS

Universal manifold mounting bracket suitable for direct mount manifolds. This bracket design enables horizontal or vertical instrument positioning. Suitable for 2" standpipe.

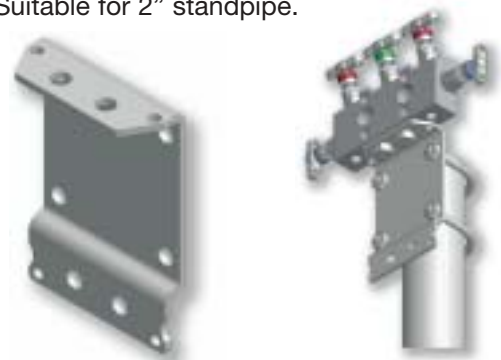

For manifold/bracket bolts add 'bolt set' suffix from matrix. Example: Bracket, 'U' bolts and manifold/bracket bolts BKT3CSB2 (suitable for HD*2HLH).

Part No. BKT4CS

Suitable for:-
 HEF*38N
 HEF*3
 HEF*58NCT
 HEF*5CT

For 'U' bolts suffix
 part no. with B
 Example BKT4CSB

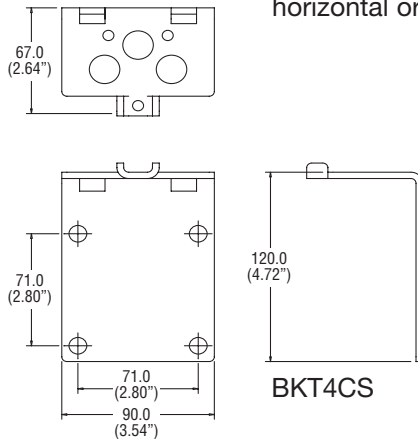

BKT4CS

For extruded style manifold blocks providing full base support for horizontal or vertical fixing to 2" standpipe.

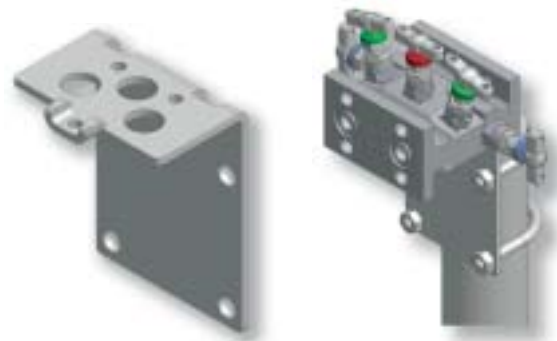

For manifold/bracket bolts add 'bolt set' suffix from matrix. Example: Bracket, 'U' bolts and manifold/bracket bolts BKT4CSB4 (suitable for HEF*2LH).

'U' Bolt with nuts and washers for 2" NB standpipe

Part No. UBACS

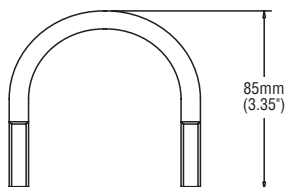

Manifold/bracket bolts c/w nuts and washers

Manifold Part No.	Bolting Set	Part No.	Suffix
HL*3M	M8 x 45 Bolt + Nuts	BS5	5
HL*3MDTP	M8 x 45 Bolt + Nuts	BS5	5
HL*3MHP	M8 x 45 Bolt + Nuts	BS5	5
HL*5M	M8 x 45 Bolt + Nuts	BS5	5
HL*5MCT	M8 x 45 Bolt + Nuts	BS5	5
HL*5MHP	M8 x 45 Bolt + Nuts	BS5	5
HD*3M	M10 x 14 Bolt	BS2	2
HD*3MDTP	M10 x 14 Bolt	BS2	2
HD*3MFF	M10 x 14 Bolt	BS2	2
HD*3MCP	M10 x 14 Bolt	BS2	2
HD*3	M10 x 14 Bolt	BS2	2
HD*5M	M10 x 14 Bolt	BS2	2
HD*5MFF	M10 x 14 Bolt	BS2	2
HD*5MCP	M10 x 14 Bolt	BS2	2
HD*5CT	M6 x 14 Bolt	BS6	6
HD*5	M6 x 14 Bolt	BS6	6
HEF*38N	M6 x 45 Bolt + Nuts	BS4	4
HEF*3	M6 x 45 Bolt + Nuts	BS4	4
HEFS58NCT	M6 x 45 Bolt + Nuts	BS4	4
HEFS5CT	M6 x 45 Bolt + Nuts	BS4	4

All nut and bolt sets are standard in Carbon Steel

'H' series 3 and 5 valve manifolds

PTFree connect™

Manifold connections

Many users continually desire the elimination of taper threads and their associated sealant.

The PTFree connect system enables users to assemble tube lines to any of the manifold ports without the need for PTFE tape or other liquid sealant.

The PTFree connection can be applied to any of the manifold featured in this catalogue. These will be factory fitted, pin locked and pressure tested.

PTFree connect enables angled tube connections to be swivelled until the optimum tube alignment position has been achieved. Assembly to the tube connector is achieved by tightening the standpipe nut one-quarter turn from the finger tight position.

Manifolds can also be supplied with male connectors using the same thread form as the PTFree connect. They can be provided factory fitted, pin locked and tested before they leave our manufacturing plant.

Some size restrictions may be necessary due to the close proximity of some connections and the across flat hexagon dimensions, as a guide PTFree connect for inlet and outlet can be up to 1/2" or 12mm o/d., drain/bleed connections should be restricted to 1/4" or 6mm. For PTFree male connectors inlet and outlet should be restricted to 3/8" or 10mm and 1/4" or 6mm o/d for drain/bleed.

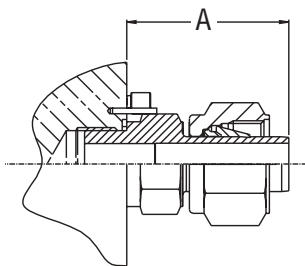

- A = 29.70mm (1.17") 6mm/1/4" tube
- A = 35.00mm (1.38") 10mm tube
- A = 35.00mm (1.38") 3/8" tube
- A = 36.90mm (1.45") 12mm/1/2" tube

PTFree connect
(Code FRC)

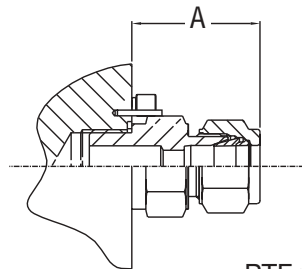

- A = 31.50mm (1.25") 6mm/1/4" tube
- A = 36.60mm (1.44") 10mm tube
- A = 36.60mm (1.44") 3/8" tube

PTFree male connectors
(Code FRCM)

Part Number Construction Examples

				Inlet, Outlet, Drain/vent/test, tube size/thread size & form		
Manifold Part No. + option	Connection Style FRC or FRCM	A-LOK(L) or CPI(B) L or B	Metric or inch tube M or I	Inlet (E) + size	Outlet (X) + size	Drain/vent/test
HDS5M	FRC	L	M	E12	Flanged	D6
Part No. HDS5MFRCLME12D6 = 5 valve direct mount manifold with A-LOK PTFree connect™ Inlet - 12mm o.d., Outlet Flanged, Drain/test - 6mm. Stainless steel construction						
HLS3M	FRC	B	I	E6	X6	-
Part No. HLS3MFRCBIE6X6 = 3 valve remote manifold with CPI PTFree connect™ Inlet - 3/8" o.d., Outlet 3/8 o.d. Stainless steel construction						

'H' series 3 and 5 valve manifolds

Material options

For full material specification see technical section

		Manifold types				
		HD*3M	HL*3M	HEF*38N	HF*38N	ML*3V4N
		HD*3	HD*3MCP	HEF*3	HF*3	
		HD*3EXT	HD*3MFF			
Material	*Insert code for selected material in part number					
Stainless steel Std	S	✓	✓	✓	CAST	✓
Monel	M	✓	✓			✓
Duplex	D1	✓	✓			✓
Super Duplex	D2	✓	✓			✓
Hasteloy	HC	✓	✓			✓
Carbon Steel	C	✓	✓	✓		
6Mo	6MO	✓	✓			✓
Titanium	T	✓	✓			✓
Incoloy 825	825	✓	✓			✓
Inconel 625	625	✓	✓			✓



All non-wetted parts ie those not in contact with the process medium will be supplied in stainless steel.

		Manifold types				
		HD*5	HD*5CT	HF*58N	HEF*58NCT	HD*5MFF
		HD*5M	HL*5	HF*5	HEF*5CT	HD*5MCP
		HD*5EXT	HL*5M			
Material	*Insert code for selected material in part number					
Stainless steel Std	S	✓	✓	CAST	✓	✓
Monel	M	✓	✓			✓
Duplex	D1	✓	✓			✓
Super Duplex	D2	✓	✓			✓
Hasteloy	HC	✓	✓			✓
Carbon Steel	C	✓	✓		✓	✓
6Mo	6MO	✓	✓			✓
Titanium	T	✓	✓			✓
Incoloy 825	825	✓	✓			✓
Inconel 625	625	✓	✓			✓

All non-wetted parts ie those not in contact with the process medium will be supplied in stainless steel.

'H' series 3 and 5 valve manifolds

Options for three valve manifolds

				Manifold part nos.			
				Page	8	8	9
							
Suffix adding sequence	Function	Read	Option Detail	Part no. suffix	HD*3M+DTP	HD*3	HD*3EXT
1	Gland packing		Graphoil	3	✓	✓	✓
2	Seating		PCTFE tip	9	✓	✓	✓
			PEEK tip	PK	✓	✓	✓
		Note 1	Roddable/rising plug, PTFE packed	RP			
			Stellite Tip	ST	✓	✓	✓
3	Optional connections	Note 2	Purge ports 1/4 NPT	UPP*	✓	✓	✓
		Note 2	Test ports 1/4 NPT	DTP*	✓	✓	✓
4	Blank plugs		Hexagon plugs 1/4 NPT (loose in box)	P	✓	✓	✓
5	Connection	Note 3	Socket weld (* insert pipe size)	SW*NB	✓	✓	✓
			Butt weld (* insert pipe size)	BW*NB	✓	✓	✓
			BSPT (* insert thread size e.g. 8K = 1/2")	*K	✓	✓	✓
		Note 4	BSPP (* insert thread size e.g. 8R = 1/2")	*R	✓	✓	✓
			Inverted connections A-LOK/CPI	*A/*Z			
		Note 5	PTFree connect (see page 22)		✓	✓	✓
6	Operating mechanism (see page 5 for functional definition)		Lockable 'T' Bar	THL	✓	✓	✓
			Anti tamper spindle	AT	✓	✓	✓
			Anti tamper spindle + key	ATK	✓	✓	✓
			Handwheel	HW	✓	✓	✓
			Lockable handwheel	LHW	✓	✓	✓
7	Mounting	Note 6	Assembled to bracket	BRK	✓	✓	✓
			56mm centres	56	✓	✓	✓
			57mm centres	57	✓	✓	✓
			Stainless steel mounting bolts 7/16 UNF	SSB	✓	✓	✓
			M10 x 1.5 C.S. mounting bolts	CSB10	✓	✓	✓
			M10 x 1.5 stainless steel mounting bolts	SSB10	✓	✓	✓
8	Condition		NACE (latest issue)	NACE	✓	✓	✓
			Cleaned and lubricated for oxygen use	OXY	✓	✓	✓
			Firesafe design	FS	✓	✓	✓
		Note 7	Heat code trace certificates	HCT	✓	✓	✓
			Test certificates	TC	✓	✓	✓
	Air testing	PT	✓	✓	✓		

Note 1 Seat material RP = standard acetal, RP9 = PCTFE, RPPK = PEEK.

Note 2 *Specify face F = front, T = top, B = base, S = side (check viability of size and position with sales).

Note 3 For tube socket use 1/16" denominations (i.e. 8 = 1/2") and change NB to TB.

For metric tube size use actual metric (mm) dimensions e.g. SW12MMTB.









Note 4 For test/purge connections in BSPP these will, due to sealing face requirements be limited to 1/8" as standard.

Note 5 **Insert seal type B1, B2, or B3.

Note 6 Bracket will include 'U' bolts and manifold/bracket bolts.

Note 7 Heat code traceable certificates for body and bonnet.

‘H’ series 3 and 5 valve manifolds

Manifold part nos.								
9	10	10	11	11	12	13	13	
								
HD*3FF	HEF*38N	HEF*3	HF*38N	HF*3	HL*3M+DTP+HP	HD*3CP	MLS3V4N	Option Detail
✓	✓	✓	✓	✓	✓	✓		Graphoil
✓	✓	✓	✓	✓	✓	✓		PCTFE tip
✓	✓	✓	✓	✓	✓	✓		PEEK tip
		✓						Roddable/rising plug, PTFE packed
✓	✓	✓	✓	✓	✓	✓		Stellite Tip
✓	✓	✓	✓	✓	✓	✓		Purge ports 1/4 NPT
✓	✓	✓	✓	✓	✓	✓		Test ports 1/4 NPT
✓	✓	✓	✓	✓	✓	✓		Hexagon plugs 1/4 NPT (loose in box)
	✓		✓		✓	✓		Socket weld (* insert pipe size)
	✓		✓		✓	✓		Butt weld (* insert pipe size)
	✓		✓		✓	✓		BSPT (* insert thread size e.g. BK = 1/2")
	✓		✓		✓	✓		BSPP (* insert thread size e.g. 8R = 1/2")
	✓	✓						Inverted connections A-LOK/CPI
	✓		✓		✓	✓		PTFree connect (see page 22)
✓			✓	✓	✓			DIN 19213 instrument seal grooves
✓	✓	✓	✓	✓	✓	✓		Lockable ‘T’ Bar
✓	✓	✓	✓	✓	✓	✓		Anti tamper spindle
✓	✓	✓	✓	✓	✓	✓		Anti tamper spindle + key
✓	✓	✓	✓	✓	✓	✓		Handwheel
✓	✓	✓	✓	✓	✓	✓		Lockable handwheel
✓	✓	✓	✓	✓	✓	✓		Assembled to bracket
✓	✓	✓	✓	✓	✓	✓		56mm centres
✓	✓	✓	✓	✓	✓	✓		57mm centres
✓	✓	✓	✓	✓		✓		Stainless steel mounting bolts 7/16 UNF
✓	✓	✓	✓	✓				M10 x 1.5 C.S. mounting bolts
✓	✓	✓	✓	✓				M10 x 1.5 stainless steel mounting bolts
✓	✓	✓	✓	✓	✓	✓	✓	NACE (latest issue)
✓	✓	✓	✓	✓	✓	✓	✓	Cleaned and lubricated for oxygen use
✓	✓	✓	✓	✓	✓	✓	✓	Firesafe design
✓	✓	✓	✓	✓	✓	✓	✓	Heat code trace certificates
✓	✓	✓	✓	✓	✓	✓	✓	Test certificates
✓	✓	✓	✓	✓	✓	✓	✓	Air testing

Accessories and spares

*Insert 9 PCTFE seat
*Insert PK PEEK seat

Description	Part number	Box quantity
PTFE manifold/instrument seals	HPTFESEAL/10	10
Graphite manifold/instrument seals	HGRAPHSEAL/10	10
Isolate valve with PTFE gland, metal seat	HBNTS*ISPTFE/3	3
Drain/bleed valve with PTFE gland, metal seat	HBNTS*DRPTFE/3	3
Equalize valve with PTFE gland, metal seat	HBNTS*EQPTFE/3	3
Isolate valve with graphoil gland, metal seat	HBNTSISGRAP/3	3
Drain/bleed valve with graphoil gland, metal seat	HBNTSDRGRAP/3	3
Equalize valve with graphoil gland, metal seat	HBNTSEQGRAP/3	3

'H' series 3 and 5 valve manifolds

Options for five valve manifolds

				Manifold part nos.			
				Page	14	14	15
							
Suffix adding sequence	Function	Read	Option Detail	Part no. suffix	HD*5M	HD*5	HD*5MFF
1	Gland packing		Graphoil	3	✓	✓	✓
2	Seating		PCTFE tip (not HP)	9	✓	✓	✓
			PEEK tip	PK	✓	✓	✓
		Note 1	Roddable/rising plug, PTFE packed	RP			
			Stellite Tip	ST	✓	✓	✓
3	Optional connections	Note 2	Purge ports 1/4 NPT	UPP*	✓	✓	✓
		Note 2	Test ports 1/4 NPT	DTP*			
4	Blank plugs		Hexagon plugs 1/4 NPT (loose in box)	P	✓	✓	✓
5	Connection	Note 3	Socket weld (* insert pipe size)	SW*NB	✓	✓	
			Butt weld (* insert pipe size)	BW*NB	✓	✓	
			BSPT (* insert thread size e.g. 8K = 1/2")	*K	✓	✓	
		Note 4	BSPP (* insert thread size e.g. 8R = 1/2")	*R	✓	✓	
			Inverted connections A-LOK/CPI	*A/*Z			
			PTFree connect (see page 22)		✓	✓	
		Note 5	DIN 19213 instrument seal grooves	DIN**	✓	✓	✓
6	Operating mechanism (see page 5 for functional definition)		Lockable 'T' Bar	THL	✓	✓	✓
			Anti tamper spindle	AT	✓	✓	✓
			Anti tamper spindle + key	ATK	✓	✓	✓
			Handwheel	HW	✓	✓	✓
			Lockable handwheel	LHW	✓	✓	✓
7	Mounting	Note 6	Assembled to bracket	BRK	✓	✓	✓
			56mm centres	56	✓	✓	
			57mm centres	57	✓	✓	
			Stainless steel mounting bolts 7/16 UNF	SSB	✓	✓	✓
			M10 x 1.5 C.S. mounting bolts	CSB10	✓	✓	✓
			M10 x 1.5 stainless steel mounting bolts	SSB10	✓	✓	✓
8	Condition		NACE (latest issue)	NACE	✓	✓	✓
			Cleaned and lubricated for oxygen use	OXY	✓	✓	✓
			Firesafe design	FS	✓	✓	✓
		Note 7	Heat code trace certificates	HCT	✓	✓	✓
			Test certificates	TC	✓	✓	✓
			Air testing	PT	✓	✓	✓

Note 1 Seat material RP = standard acetal, RP9 = PCTFE, RPPK = PEEK.

Note 2 *Specify face F = front, T = top, B = base (check viability of size and position with sales).

Note 3 For tube socket use 1/16" denominations (i.e. 8 = 1/2") and change NB to TB.

For metric tube size use actual metric (mm) dimensions e.g. SW12MMTB.









Note 4 For test/purge connections in BSPP these will, due to sealing face requirements be limited to 1/8" as standard.

Note 5 **Insert seal type B1, B2, or B3.

Note 6 Bracket will include 'U' bolts and manifold/bracket bolts.

Note 7 Heat code traceable certificates for body and bonnet.

'H' series 3 and 5 valve manifolds

Manifold part nos.								
15	16	16	17	17	18	18	19	
								
HD*5CT	HD*5EXT	HD*5MCP	HF*5	HF*58N	HEF*5CT	HEF*8MCT	HL*5M+HP	Option Detail
✓	✓	✓	✓	✓	✓	✓	✓	Graphoil
✓	✓	✓	✓	✓	✓	✓	✓	PCTFE tip
✓	✓	✓	✓	✓	✓	✓	✓	PEEK tip
					✓	✓		Roddable/rising plug, PTFE packed
✓	✓	✓	✓	✓	✓	✓	✓	Stellite Tip
✓	✓	✓	✓	✓	✓	✓	✓	Purge ports 1/4 NPT
✓	✓	✓	✓	✓	✓	✓	✓	Test ports 1/4 NPT
✓	✓	✓	✓	✓	✓	✓	✓	Hexagon plugs 1/4 NPT (loose in box)
✓	✓	✓	✓	✓	✓	✓	✓	Socket weld (* insert pipe size)
✓	✓	✓	✓	✓	✓	✓	✓	Butt weld (* insert pipe size)
✓	✓	✓	✓	✓	✓	✓	✓	BSPT (* insert thread size e.g. BK = 1/2")
✓	✓	✓	✓	✓	✓	✓	✓	BSPF (* insert thread size e.g. 8R = 1/2")
			✓	✓	✓	✓		Inverted connections A-LOK/CPI
✓	✓	✓	✓	✓	✓	✓	✓	PTFree connect (see page 22)
✓	✓	✓	✓	✓	✓	✓	✓	DIN 19213 instrument seal grooves
✓	✓	✓	✓	✓	✓	✓	✓	Lockable 'T' Bar
✓	✓	✓	✓	✓	✓	✓	✓	Anti tamper spindle
✓	✓	✓	✓	✓	✓	✓	✓	Anti tamper spindle + key
✓	✓	✓	✓	✓	✓	✓	✓	Handwheel
✓	✓	✓	✓	✓	✓	✓	✓	Lockable handwheel
✓	✓	✓	✓	✓	✓	✓	✓	Assembled to bracket
✓	✓	✓	✓	✓	✓	✓	✓	56mm centres
✓	✓	✓	✓	✓	✓	✓	✓	57mm centres
✓	✓	✓	✓	✓	✓	✓	✓	Stainless steel mounting bolts 7/16 UNF
✓	✓	✓	✓	✓	✓	✓	✓	M10 x 1.5 C.S. mounting bolts
✓	✓	✓	✓	✓	✓	✓	✓	M10 x 1.5 stainless steel mounting bolts
✓	✓	✓	✓	✓	✓	✓	✓	NACE (latest issue)
✓	✓	✓	✓	✓	✓	✓	✓	Cleaned and lubricated for oxygen use
✓	✓	✓	✓	✓	✓	✓	✓	Firesafe design
✓	✓	✓	✓	✓	✓	✓	✓	Heat code trace certificates
✓	✓	✓	✓	✓	✓	✓	✓	Test certificates
✓	✓	✓	✓	✓	✓	✓	✓	Air testing

Accessories and spares

*Insert 9 PCTFE seat
*Insert PK PEEK seat

Description	Part number	Box quantity
PTFE manifold/instrument seals	HPTFESEAL/10	10
Graphite manifold/instrument seals	HGRAPHSEAL/10	10
Isolate valve with PTFE gland, metal seat	HBNTS*ISPTFE/3	3
Drain/bleed valve with PTFE gland, metal seat	HBNTS*DRPTFE/3	3
Equalize valve with PTFE gland, metal seat	HBNTS*EQPTFE/3	3
Isolate valve with graphoil gland, metal seat	HBNTSISGRAP/3	3
Drain/bleed valve with graphoil gland, metal seat	HBNTSDRGRAP/3	3
Equalize valve with graphoil gland, metal seat	HBNTSEQGRAP/3	3



TECHNOLOGY, APPLIED™

Parker Instrumentation Sales & Service Locations

Visit www.parker.com

Europe - Call free of charge 00800 27 27 5374

U.S. - Call toll free
1-800-272-7537
(1-800-C-Parker)

Sales Offices

Africa	(27) (11) 392 7280
Argentina	(58) (11) 4752 4169
Australia	(61) (2) 9634 7777
Azerbaijan	(99) (412) 983 966
Brazil	(55) (12) 3545100
Canada	(905) 945-2274
China	(86) (21) 6445 9339
Egypt	(2) 025194018
Finland	(358) 9476 731
France	(33) 141 115390
Germany	(49) 6134 204 243
Hong Kong	(852) 2428 8008
India	(91) (22) 5771671
Italy	(39) (2) 451921
Japan	(81) (3) 6408 3900
Korea	(82) (2) 598 0414
Latin American/ Caribbean Countries	(305) 470-8800
Norway	(47) (51) 826300
Singapore	(65) 2615233
Sweden	(46) 157434900
Taiwan	(886) (2) 8787 3780
United Arab Emirates	(971) (2) 6788587
United Kingdom	(44) 1271 313131
Venezuela	(58) (2) 2385422



Parker Hannifin plc
Instrumentation Products Division
Riverside Road
Pottington Business Park
Barnstaple, Devon EX31 1NP
England
Tel: +44 (0)1271 313131
Fax: +44 (0)1271 373636



Parker Hannifin Corp.
Instrumentation Valve Division
2651 Alabama Hwy 21 N
Jacksonville, AL36265
U.S.A
Tel: (256) 435 2130
Fax: (256) 435 7718



Parker
Instrumentation

Visit us on the web at www.parker.com/ipd